

Chopper Spotter

Helicopter Ground Handling



2021

www.chopperspotter.com

INTRODUCTION

Est. 1989 – Celebrating 30+ Years!

The Chopper Spotter powered dolly was first created for a Bell 47G helicopter to fill the need for a highly reliable, single operator helicopter ground handling unit. Since its inception, Chopper Spotter, Inc. has grown extensively and is committed to the highest standard of excellence with every unit built.

We feature three models of the Chopper Spotter:

The **Model E** is our base model which provides excellent functionality and value for lighter helicopters. This unit is available with an optional power receptacle for auxiliary power capability.

The **Model MS** is our midrange model. The MS Model features two extra batteries (four total) along with a built-in auxiliary power receptacle. The Model MS is a robust and versatile helicopter ground handler, as well as a reliable ground power unit. In addition, the MS Model's super heavy-duty casters with dual wheels further enhance the unit's load capacity and ability to disperse the weight of that load.

The **Model 4** is not only our premium flagship model, but it is also our most popular. The Model 4 was developed in response to the need for moving larger, heavier helicopters. The model 4 boasts time tested durability, enhanced stability and unsurpassed versatility. While operating the Model 4, a second pair of lift arms help stabilize the helicopter and keep it level.

Chopper Spotter, Inc. is proud to produce the safest, most versatile, and most maneuverable powered helicopter ground handling units in the world. With unrivaled dedication to the highest level of quality and commitment to our customers, let Chopper Spotter, Inc. be your first choice for superior ground handling support equipment for years to come.

Sincerely,



Chris Brekken and the Chopper Spotter Team
Chopper Spotter, Inc.
15124 Business Parkway
Rosemount, MN 55068
USA



Chopper Spotter® is a Registered Trademark of Chopper Spotter, Inc.

OUR MISSION

For over 30 years, Chopper Spotter has set the standard for value and utility. No other ground handling equipment is easier to load, safer for the helicopter and operator, more maneuverable, or more versatile than the Chopper Spotter. Continuing a tradition of excellence, Chopper Spotter, Inc. is proud to support helicopter owners and operators around the world.

We have proudly served customers in:

Abu Dhabi
Andorra
Argentina
Australia
Austria
Balearic Islands
Belgium
Bosnia
Brazil
Burkina Faso
Canada
Chile
China
Colombia
Egypt
France
French Guiana

Germany
Greece
Ireland
Israel
Italy
Japan

Macao
Malaysia
Mauritius
Mexico
Morocco
New Caledonia

New Zealand
Norway
Peru
Poland
Portugal
Puerto Rico
Reunion Island
Russia
Singapore
South Africa
Spain
Sweden
Switzerland
Trinidad
Turkey
United Kingdom
United States

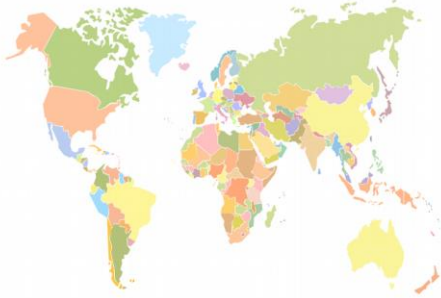

Chopper Spotter, Inc. produces 100% of the Chopper Spotter ground handling equipment at our Minnesota manufacturing facility. This facility maintains a dedication to unsurpassed quality standards for every Chopper Spotter built.



Chopper Spotter, Inc. is located in Rosemount, MN, just south of the Twin Cities of Minneapolis and St. Paul.

N 44° 43' 47"
W 93° 07' 19"

Made in the USA



GOING WIRELESS – THE NEW STANDARD

All Chopper Spotter models are now equipped with our wireless handheld controller as standard. This new controller features an ergonomic design, improved build quality, and outstanding reliability.

*Convert your wired Chopper Spotter to wireless with our Wireless Conversion Kit!

Wireless handheld controller with improved ergonomics



Electronic motor controller and wireless receiver with built-in battery gauge



The new generation of Chopper Spotters also feature a black welded hydraulic cylinder and a sleek, black motor casing.



OPERATION

The Chopper Spotter requires just one person to quickly load and move a helicopter with unmatched ease and safety for both the operator and the helicopter.

The Chopper Spotter is the original ground handling unit created to load the helicopter from the rear. Simply roll it under the helicopter and attach the “yokes” to the wheel attachment points on the skids.

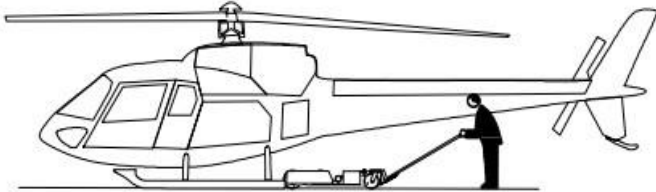

Once the yokes are attached, you'll be on the move in just four easy steps:

1. Take the handheld controller in hand and step back to the rear of the helicopter.
2. Take ahold of the tail.
3. Hold “UP” on the handheld controller to raise the helicopter.
4. Use the “FWD/REV” switch to begin moving while using the tail of the helicopter to steer.

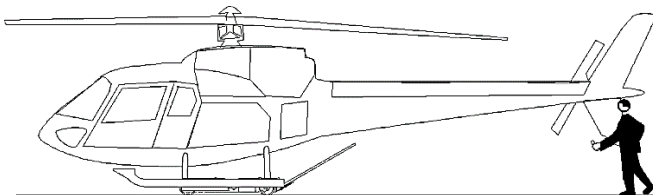

FAQ

Why should I invest in a Chopper Spotter ground handling unit for my helicopter operations? Chopper Spotter holds utility and longevity in our highest regards. Made in the U.S.A., the Chopper Spotter has been in production for over 30 years with original units still in use today. Units withstanding three decades of use is a testament to our proven track record of safety, reliability, and unmatched dedication to helicopter operators around the world.

Does the Chopper Spotter take up a lot of space in the hangar? Not only does the Chopper Spotter have a smaller footprint than other transporters, it can also be stored directly underneath the helicopter.

Can one person operate the Chopper Spotter? Yes. The Chopper Spotter is easily and safely operated by just one person.

Is the Chopper Spotter easy to load? Yes. Because the Chopper Spotter pivots on its drive wheel, it is extremely easy to maneuver and effortlessly rolls under the helicopter. The yokes are then simply attached to the ground handling attachment points on the helicopter skids.

Why load from the rear of the helicopter? Loading from the rear of the helicopter makes it easier for the operator to see the engagement points on the skids. It also lessens the chance of interfering with or damaging any accessories mounted to nose of the helicopter. The operating position at the tail allows the operator to have excellent visibility and control.

Can the Chopper Spotter transition the helicopter up and down ramps? Yes. The Chopper Spotter has more than enough torque for even the heaviest of helicopters. The electronic controller also provides braking capabilities when transitioning down ramps.

Could the Chopper Spotter damage the helicopter? The Chopper Spotter is the safest transporter available. The Chopper Spotter lifts the helicopter from the same attachment points as the ground handling wheels, so there is no unnecessary contact with the skids. The operator also has superior control of maneuverability, helping to prevent operator error or damage to the helicopter.

Will the Chopper Spotter operate on grass or loose gravel? No. The Chopper Spotter is designed for use on paved surfaces, hard packed gravel, or other solid surfaces.

Why use polyurethane wheels instead of rubber wheels? Polyurethane wheels are much more robust than rubber wheels. In addition, polyurethane wheels have a low rolling resistance for high efficiency.

Do the polyurethane wheels have good traction? The polyurethane wheels provide excellent traction. In addition, the grooved drive wheel improves mobility in snowy and icy conditions.

Can the Chopper Spotter be towed? Yes. Tie down hooks are located on the rear of the Chopper Spotter. To avoid damaging the motor, the Chopper Spotter should never be towed faster than normal maximum operating speed (3 feet per second) unless the drive chain is removed.

What type of battery does the Chopper Spotter use? Optima AGM batteries are standard. These batteries are non-spillable and safe for shipping around the world via air and ground.

How are the batteries charged? An on-board automatic charger is standard.

How long will the battery charge last? The Model E will operate continuously for 3-4 hours, while the Model MS and Model 4 will operate for 6-8 hours continuously.

How do I determine the state of the battery charge? Each chopper spotter comes standard with a digital battery gauge allowing the user to quickly and easily check the charge of the batteries.

Can the Chopper Spotter be used as an Auxiliary Power Unit (APU)? The Model MS and the Model 4 are built standard with auxiliary power receptacles (optional on the Model E). The power cord can be purchased separately.

Can the Chopper Spotter roll when the powered off or when the batteries are discharged? The Chopper Spotter rolls freely when powered off or when the FWD/REV switch is in its neutral position. The Chopper Spotter should never be left unmanned on significant slopes.

Does the Chopper Spotter have braking action? If the operator needs to stop quickly, the electronic controller has a braking feature. Simply flip the switch on the handheld controller to the opposite direction. The Chopper Spotter will quickly and gently come to a stop.

DIMENSIONS

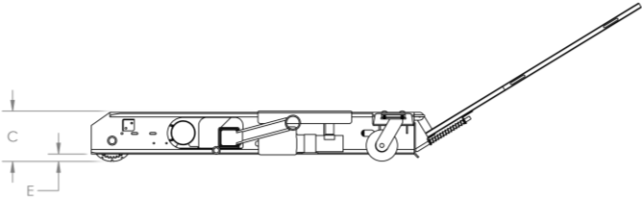
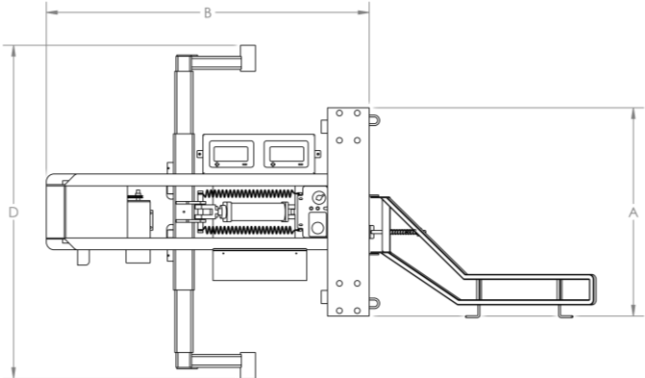

Model E

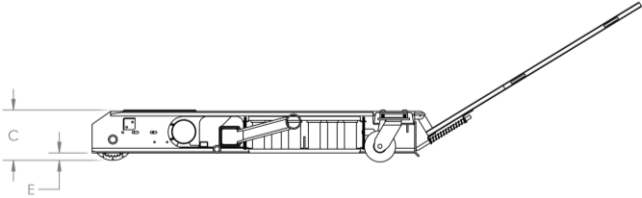
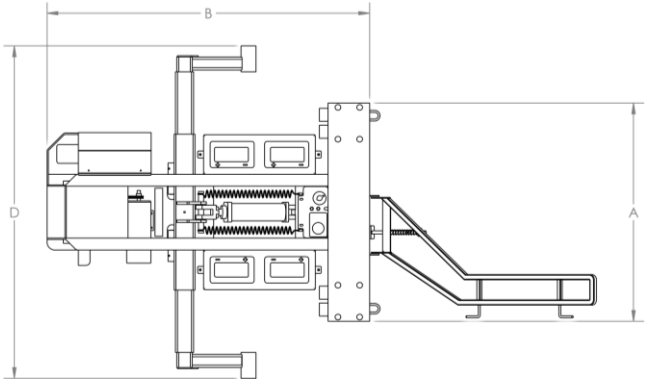

Model MS

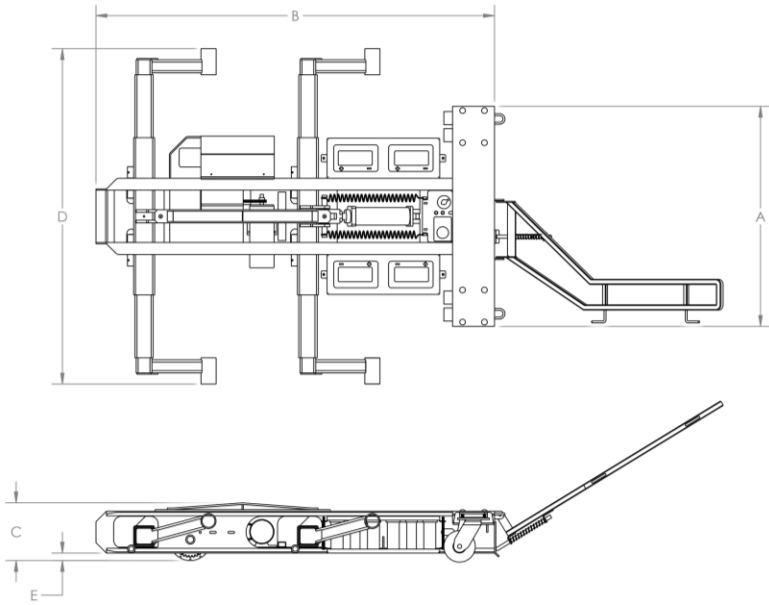

Model 4

Dimension	Model E	Model MS	Model 4
A (Width)	40.0 in (101.6 cm)	42.0 in (106.7 cm)	42.0 in (106.7 cm)
B (Length)	62.0 in (157.5 cm)	62.0 in (157.5 cm)	76.0 in (193.0 cm)
C (Height)	10.0 in (25.4 cm)	10.0 in (25.4 cm)	11.4 in (29.0 cm)
D (Minimum Arm Width)	64.0 in (162.6 cm)	64.0 in (162.6 cm)	64.0 in (162.6 cm)
E (Ground Clearance)	1.7 in (4.3 cm)	1.7 in (4.3 cm)	1.7 in (4.3 cm)

SPECIFICATIONS

	Model E	Model MS	Model 4
Lifting Capacity	4,500 lb (2041 kg)	9,000 lb (4082 kg)	11,900 lb (5398 kg)
Motor	1 hp DC	1 hp DC	1 hp DC
Batteries	2 Optima AGM Non-spillable	4 Optima AGM Non-spillable	4 Optima AGM Non-spillable
Battery Life	3-4 Hours	6-8 Hours	6-8 Hours
Charger Output	24 V, 6 A	24 V, 10 A	24 V, 10 A
Charger Input	117 V @ 60 Hz or 230 V @ 50-60 Hz	117 V @ 60 Hz or 230 V @ 50-60 Hz	117 V @ 60 Hz or 230 V @ 50-60 Hz
APU	Optional	Standard	Standard
LED Spotlight	Optional	Optional	Standard
Drive Wheel	Grooved (8 in x 5 in)	Grooved (8 in x 5 in)	Grooved (8 in x 5 in)
Caster Wheels	Single Wheel Casters*	Dual Wheel Casters	Dual Wheel Casters
Lifting System	Hydraulic	Hydraulic	Hydraulic
Braking	Electric	Electric	Electric
Speed Control	Variable up to 3 ft/s (1 m/s)	Variable up to 3 ft/s (1 m/s)	Variable up to 3 ft/s (1 m/s)
Overload Protection	100 Amp Breaker (auto reset)	100 Amp Breaker (auto reset)	100 Amp Breaker (auto reset)
Color	Safety Yellow	Safety Yellow	Safety Yellow

*Dual Wheel Casters available for Model E units

PRICING

UNITS	
Chopper Spotter Model E	\$12,712.00
Chopper Spotter Model MS	\$15,772.00
Chopper Spotter Model 4	\$17,537.00
UPGRADES	
APU Power Cable	\$839.00
APU Receptacle (Included on Model MS and Model 4)	\$609.00
LED Spotlight (Included on Model 4)	\$194.00
ADDITIONAL YOKES/ADAPTERS	
AS350/355, EC120, EC130/135, MD500/520, Bell 206, Bell Jet Ranger, Bell 407, UH-1, OH 58	\$891.00
SA315 Lama, SA341 Gazelle, R22, R44, Bell 47	\$744.00
Universal Yokes	\$1379.00
Heavy Duty Universal Yokes	\$1495.00
ADDITIONAL ITEMS	
Wireless Conversion Kit	\$2099.00
Handheld Controller	\$550.00
Battery (Optima AGM)	\$241.00

Each Chopper Spotter comes complete with the necessary accessories for your specific model of helicopter. Standard equipment includes batteries, battery charger, standard lifting adapters, and yokes for one model of helicopter. All prices include packaging but exclude freight charges.

We strive to secure the best shipping rates for our customers. Payment is required before shipping of Chopper Spotter units and parts. Prices subject to change without notice. Please request a quote. The Chopper Spotter® is Conformité Européenne (CE) compliant. For international shipments, duties, taxes, and local fees are the sole responsibility of the buyer.

Chopper Spotter® is a registered trademark of Chopper Spotter, Inc.



Chopper Spotter

Still a Better Idea!

Phone: +1 608.537.2049

Email: info@chopperspotter.com

www.chopperspotter.com